

REVISION HISTORY

REV	DESCRIPTION	DATE	APPROVED

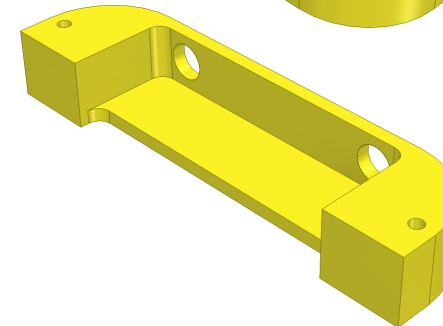
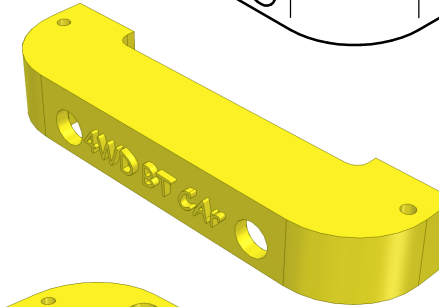
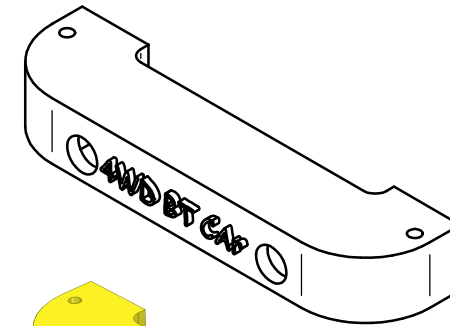
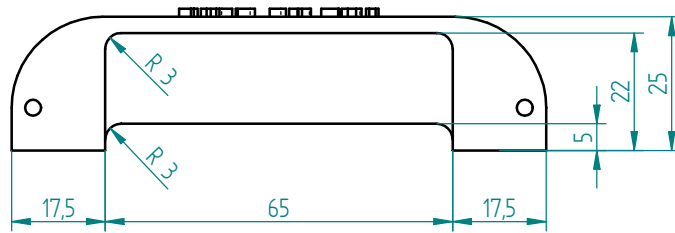
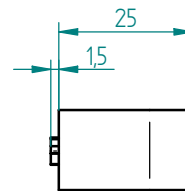
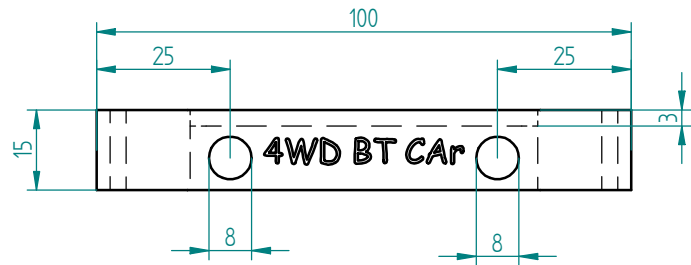
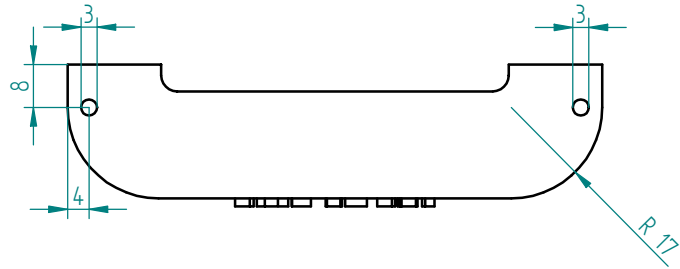

Solid Edge Teacher Edition

	NAME	DATE	Solid Edge	
DRAWN	BOA MSII	09/04/24		
CHECKED			TITLE	
ENG APPR				
MGR APPR				
UNLESS OTHERWISE SPECIFIED DIMENSIONS ARE IN MILLIMETERS ANGLES ±X.X° 2 PL ±XXX 3 PL ±XXXX			SIZE A3	DWG NO
			REV	
			FILE NAME: Bumper led 8 mm achter 01.dft	
			SCALE:	WEIGHT:
			SHEET 1 OF 1	